

PCN – Process Change Notification

Change:	MA208.A.AB.007
Date:	2016/09/29
Author	Annie Nien

Affected Products

Model#	Part Number	Changes
MA.208 Antenna Assembly GPS 3M RG-174 FAKRA Code C 2G/3G/4G 3M CFD-200 FAKRA Code D	MA208.A.AB.007	Product part number, labels, heat-shrink tubes and 3M double-sided adhesive foam.
		Packaging rules.

Type of Change

- Hardware Modification
 Production Process Advance
 Others –Packaging rules changing.

Description of Change

1. Amend the part number from MA.208.A.AB.007 to MA208.A.AB.007
2. Amend Cellular Label to white 2G/3G/4G Label and the direction.
3. Add Heat-Shrink tube dimensions and tolerances.
4. Amend 3M double-sided adhesive foam dimensions and tolerances
5. Amend product bagging direction and change product SPQ label to bottom left position on the large PE bag.

Schedule

2016, Sep, Taoglas will input New packaging rules.

Forecast Estimated Transition Date

September /2016

Illustration of Change (MA208.A.AB.007)
Old Drawing

		REV
<small>This drawing and its inherent design concepts are property of Taoglas. Not to be copied or given to third parties without the written consent of Taoglas.</small>		B
TITLE:	MA.208 Antenna Assembly	
	GPS 3M RG174 FAKRA C	
	Cellular 3M CFD200 FAKRA D	
PART NO.:	MA.208.A.AB.007	

	Name	P/N	Material	Finish	QTY
1	Housing	000111I030007A	ABS	Black	1
2	Closed Cell Foam	001011I030007A	F 100	Black	1
3	3M Double Adhesive	001011I030007A	3M 9448 B	White LIner	1
4	Heat Shrink Tube	001311F000007A	PE	Black	1
5	Clear Label	001011I040007A	Coated Paper	Black	1
6	GPS Label	001011F000007A	Coated Paper	Orange	1
7	Cellular Label	001011F020007A	Coated Paper	Blue	1
8	Heat Shrink Tube	001311F010007A	PE	Black	1

	Name	P/N	Spec	Finish	QTY
VV	Connector Type	202313I000007A	FAKRA C	Blue	1
WW	Connector Type	202413I000007A	FAKRA D	Violet	1
XX	Cable Length		3000mm ±120mm		2
YY	Cable Type	301313A000007A	RG174	Black	1
ZZ	Cable Type	301413A000007A	CFD 200	Black	1

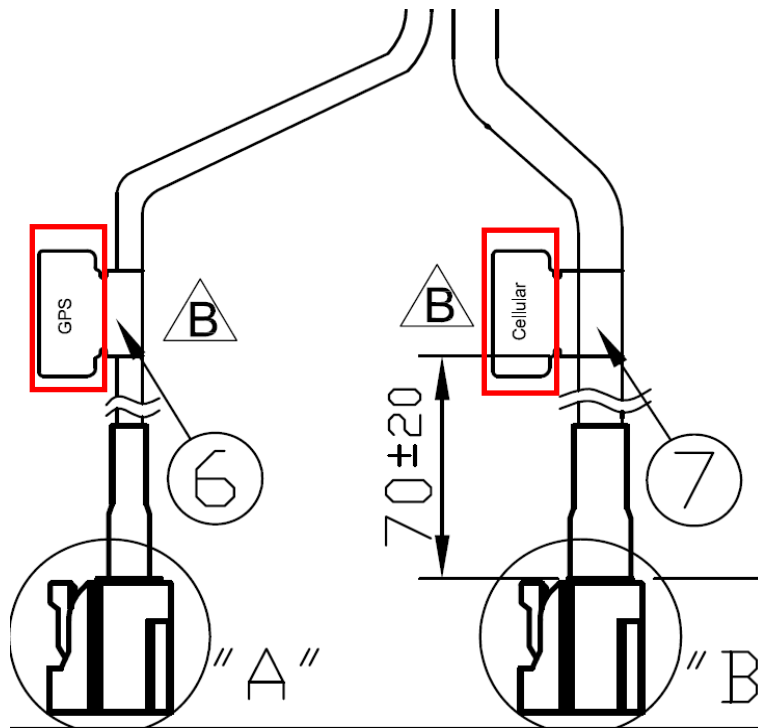
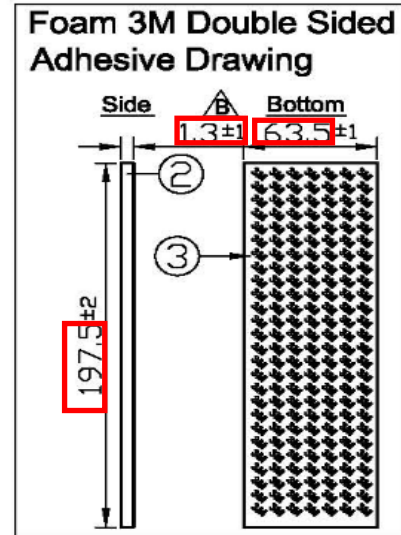

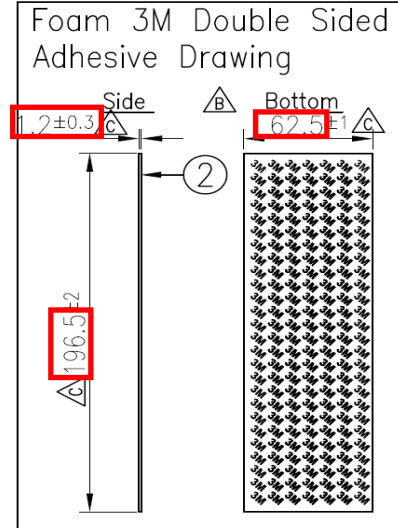

Illustration of Change (MA208.A.AB.007)
New Drawing

		REV
<small>This drawing and its inherent design concepts are property of Taoglas. Not to be copied or given to third parties without the written consent of Taoglas.</small>		C
TITLE. : MA.208 Antenna Assembly GPS 3M RG174 FAKRA C 2G/3G/4G 3M CFD200 FAKRA D		
PART NO. : MA208 A.AB.007		



	Name	P/N	Material	Finish	QTY
1	Housing	000111I030007A	ABS	Black	1
2	3M Double Adhesive Foam	001015I030000A	3M 1600TB	Blue Liner	1
3	Heat Shrink Tube	001315C030000A	PE	Black	1
4	Clear Label	001011I040007A	Coated Paper	Black	1
5	GPS Label	001011F000007A	PEPA	Orange	1
6	2G/3G/4G Label	001014A000007A	PEPA	White	1
7	Heat Shrink Tube	001315C020000A	PE	Black	1

	Name	P/N	Spec	Finish	QTY
W	Connector Type	202313I000007A	FAKRA C	Blue	1
WW	Connector Type	202413I000007A	FAKRA D	Violet	1
YY	Cable Type	301315C000000A	RG174	Black	1
ZZ	Cable Type	301415C010000A	CFD 200	Black	1

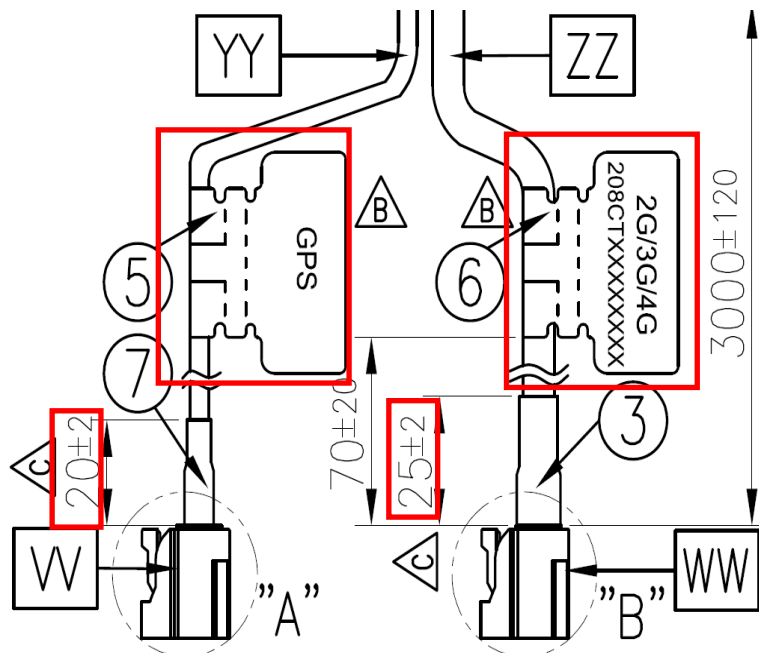
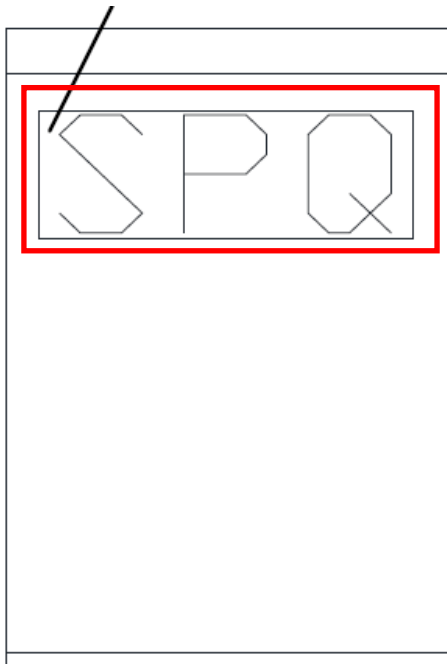
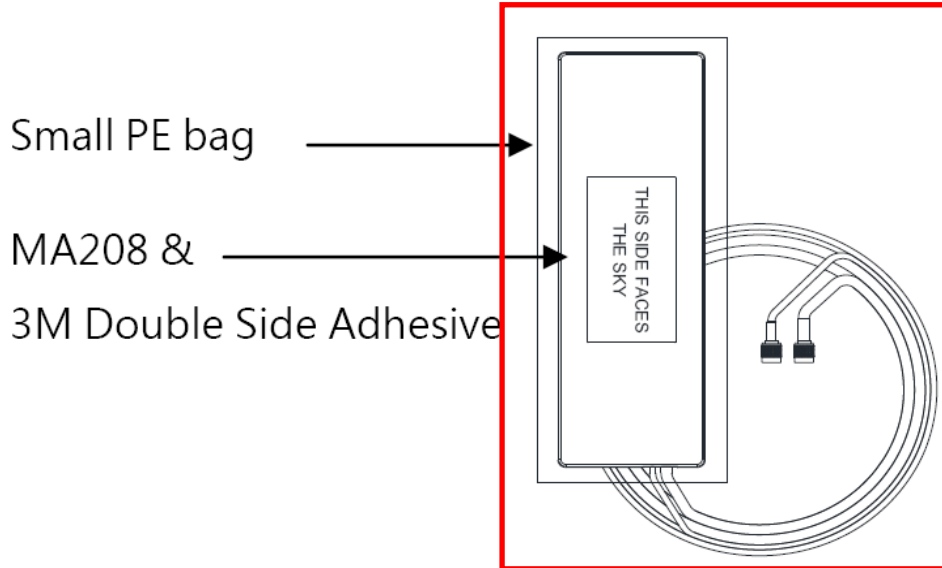
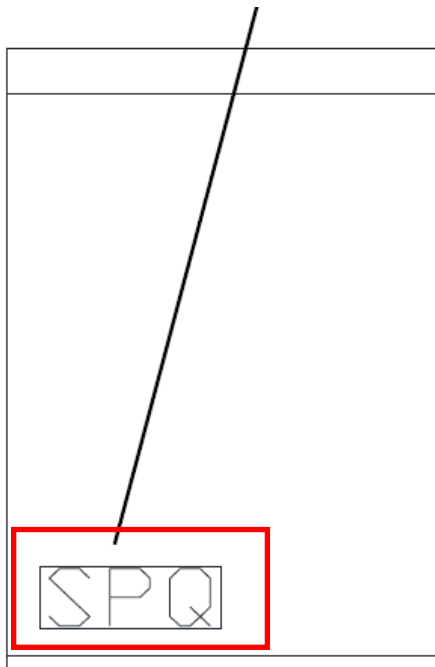
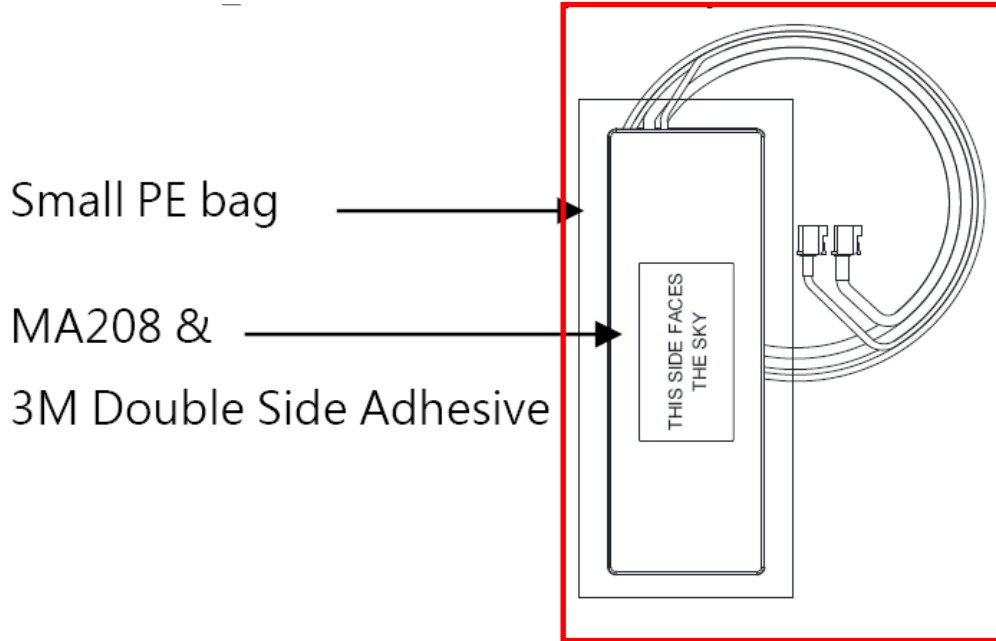

Illustration of Change (MA208.A.AB.007)
Old Package Rules



1PCS per big PE bag

Illustration of Change (MA208.A.AB.007)
New Package Rules



1PCS per big PE bag